USER'S MANUAL

Label Printer

BTP-L540



Shandong New Beiyang Information
Technology Co., Ltd

Declaration

Information in this document is subject to change without notice. SHANDONG NEW BEIYANG INFORMATION TECHNOLOGY CO., LTD. (hereinafter referred to as "SNBC") reserves the right to improve products as new technology, components, software, and hardware become available. If users need further data about these products, please feel free to contact SNBC or our local dealer.

No part of this document may be reproduced or transmitted in any form or by any means for any purpose without the express written permission of SNBC.

Copyright

Copyright © 2012 by SNBC

Printed in China

Version 1.1

Trademark

Our Registered trademark: **SNBC**®

Warning and caution

 **Warning:** Items shall be strictly followed to avoid injury or damage to body and equipment.

 **Caution:** Items with important information and prompts for operating the printer.

SNBC has been approved by the following certifications:

ISO9001 Quality Control System

ISO14001 Environmental Management System

OHSAS18001 Occupational Health and Safety Management System

IECQ QC080000 Hazardous Substance Process Management System

Safety Instructions

Before installing and using the printer, please read the following items carefully.

1. Safety warning



The print head is a thermal element and it is at a high temperature during printing or just after operation, therefore do not touch it or its peripherals for safety's sake.



The print head is an ESD-sensitive device. To prevent damage, do not touch either its printing parts or connecting parts.

2. Notices

- 1) Install the printer on a flat and stable surface;
- 2) Reserve adequate space around the printer so that convenient operation and maintenance can be performed;
- 3) Keep the printer far away from water source, and do not expose the printer to direct sunlight, strong light and heat;
- 4) Do not use or store the printer in a place exposed to high temperature, high humidity or serious pollution;
- 5) Do not place the printer in a place exposed to vibration or impact;
- 6) No condensation is allowed to the printer. In case of such condensation, do not turn on the power until it has completely gone away;
- 7) Connect the printer power to an appropriate grounding outlet. Avoid sharing one electrical outlet with large power motors or other devices that may cause the fluctuation of voltage;

- 8) Disconnect the power when the printer is deemed to idle for a long time;
- 9) Don't spill water or other electric materials into the printer (e.g. metal). In case this happens, turn off the power immediately;
- 10) Do not allow the printer to start printing when there is no recording paper installed; otherwise the print head and platen roller will be damaged;
- 11) To ensure quality print and normal lifetime, use recommended paper or its equivalent;
- 12) Shut down the printer when connecting or disconnecting interfaces to avoid damages to control board;
- 13) Set the print darkness to a lower grade as long as the print quality is acceptable. This will help to keep the print head durable;
- 14) Avoid turning on and off the printer frequently. It is advised to turn on the printer at least 2 seconds after the printer is turned off;
- 15) Do not disassemble the printer without permission of a technician, even for repairing purpose;
- 16) Keep this manual safe and at hand for reference purpose.

Contents

1 Product description.....	1 -
1.1 Introduction	1 -
1.2 Unpacking and checking.....	1 -
1.3 Appearance and module	2 -
1.4 Introduction of main modules	3 -
2 Printer installation	5 -
2.1 Installation position	5 -
2.2 Paper roll installation	5 -
2.3 Power adapter connection.....	6 -
2.4 Communication cable connection.....	7 -
2.5 Start the printer	7 -
2.5.1 Power-on and self-test.....	7 -
2.5.2 Printing self-test page	8 -
2.6 Driver setup.....	8 -
3 Printer operations	11 -
3.1 LED, buzzer, feed button and LCD	11 -
3.1.1 LED functions.....	11 -
3.1.2 Button functions	11 -
3.1.3 Buzzer functions.....	12 -

3.1.4 LCD functions.....	- 12 -
3.2 Printer status and operation	- 12 -
3.2.1 Printer status	- 12 -
3.2.2 Daily operations	- 13 -
3.3 Printer parameter settings	- 14 -
3.3.1 Button menu settings	- 14 -
3.3.2 Detailed parameter setting range.....	- 17 -
3.4 Sensor position adjustment	- 18 -
3.5 Print position adjustment	- 20 -
4 Routine maintenance	- 23 -
4.1 Cleaning print head.....	- 23 -
4.2 Cleaning the sensor	- 23 -
4.3 Cleaning platen roller	- 24 -
5 Troubleshooting.....	- 26 -
5.1 Troubleshooting.....	- 26 -
5.2 Print quality problems	- 28 -
6 Appendix.....	- 29 -
Appendix 1 technical specification.....	- 29 -
Appendix 1.1 main technical specifications	- 29 -
Appendix 1.2 technical specifications of paper.....	- 32 -

Appendix 2 self-test page	- 33 -
Appendix 2.1 printer configuration information	- 33 -
Appendix 3 print and paper out position	- 34 -
Appendix 4 communication interface.....	- 36 -
Appendix 4.1 serial interface.....	- 36 -
Appendix 4.2 parallel interface.....	- 37 -
Appendix 4.3 USB interface.....	- 37 -
Appendix 4.4 Ethernet interface.....	- 38 -
Appendix 5 operation guide for paper loading under peel-off mode (optional)	- 39 -

1 Product description

1.1 Introduction

BTP-L540 label printer is an ideal label and barcode printing device for office use, with delicate appearance and excellent performance. It can apply to many fields, such as real-time label printing, product label batch printing, transportation and logistics label printing, medical label printing and business label printing.

BTP-L540 label printer can be connected to the peripherals via USB or other interfaces and can provide universal drivers under the operating systems such as Windows 2000/Windows XP/Windows server 2003/ Windows Vista/ Windows server 2008/ Windows 7/ Windows 8 and other applications.

Main features:

- Thermal printing;
- Low noise, high speed printing;
- Easy paper loading, convenient operation;
- With 32 bit high speed microprocessor;
- Adopting heat history and auto temperature adaptation control;
- Adopting a new type of print head with long lifetime, high printing quality;
- Supporting continuous paper, label paper, marked paper, etc.

1.2 Unpacking and checking

Open the packaging, and check the items according to the packing list. Please contact SNBC or your local dealer if there is shortage or

damage (communication cables are optional depending on the printer interface type).

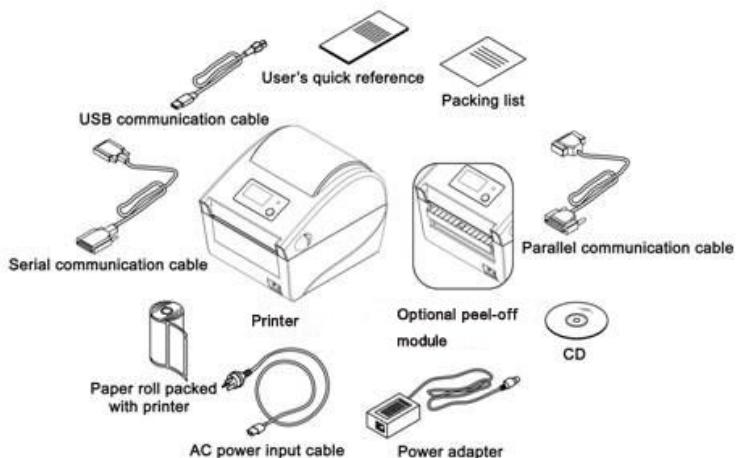

Figure 1.2-1

1.3 Appearance and module

- | | |
|-------------------------------------|----------------------------------|
| 1—window | 2—top cover |
| 3—LCD (optional) | 4—Logo plate |
| 5—bottom cover | 6—guard board for bottom cover |
| 7—button | 8—power switch |
| 9—cover open lever | 10—LED |
| 11—tear-off bar | 12—print head fixing plate |
| 13—print head | 14—latch |
| 15—guard board for print head | 16—transmissive sensor |
| 17—upper path | 18—paper roll holder baffle |
| 19—paper roll holder | 20—sensor cover board |
| 21—platen roller shaft sleeve | 22—platen roller |
| 23—lower path | 24—paper roll holder thumb wheel |
| 25—entrance for external paper roll | 26—9-pin serial interface baffle |

27—serial interface

29—USB interface

31—micro switch

28—interface board

30—24V power interface

32—reflective sensor

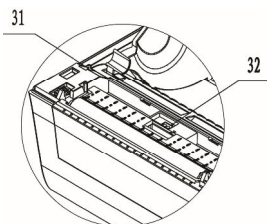
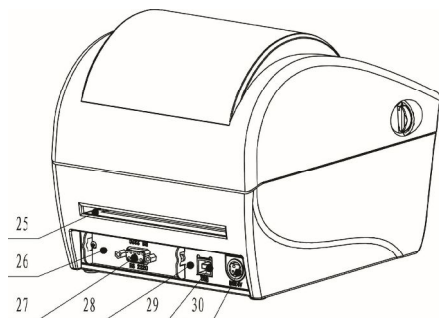
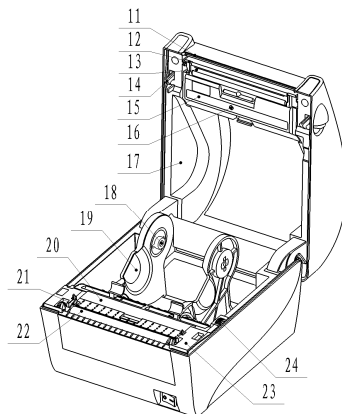
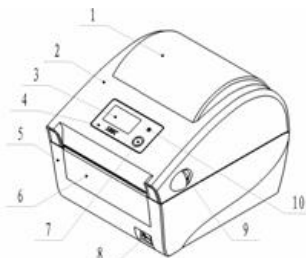

1.4 Introduction of main modules

- 1) Button and LED (7, 10): indicate the printer status and complete printing function;
- 2) Power switch (8): press “O” to power off and press “—” to power on;
- 3) Transmissive sensor (16): used for calibration, detection and location of media like label paper;

- 4) Paper roll holder baffle (18), paper roll holder (19): support paper roll holder and stop paper roll holder from shaking;
- 5) Print head micro switch (31): used to detect whether the print head is uplifted or pressed down;
- 6) Reflective sensor (32): used for the calibration, detection and location of media like black marked paper.

2 Printer installation

2.1 Installation position

Flatly place the printer on the operation table, which must be waterproof, moistureproof and dustproof. The maximal tilted angle should not exceed $\pm 15^\circ$ during installation.

2.2 Paper roll installation

- 1) Pull the cover open lever towards the front of the printer and turn the top cover upward to open it (see figure 2.2-1);
- 2) Pull the left and right paper holders apart and load the paper roll, then pull the front of paper roll out to spread it in the print path, and push the paper under the paper guide (see figure 2.2-2); turn the thumb wheel properly in the direction shown in the figure to decrease the force on paper roll (see figure 2.2-3);
- 3) Ensure the paper is installed in the path correctly, and close the top cover;
- 4) If the diameter of paper roll is very big, use the corresponding tool to remove the paper holder baffles, then turn the baffles, and insert them into the center holes of the left and right paper holders along the guiding slot (see figure 2.2-4);

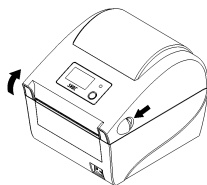

Figure 2.2-1 open top cover

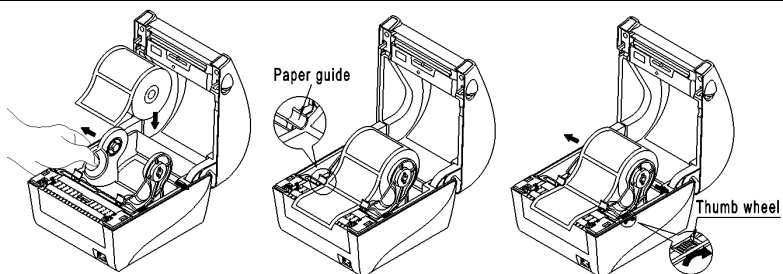

Figure 2.2-2 load paper roll

Figure 2.2-3 adjust thumb wheel

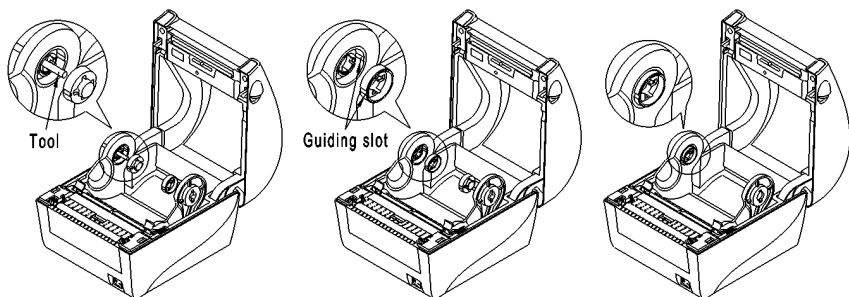

Figure 2.2-4 change the installation way of paper holder baffle

2.3 Power adapter connection

- 1) Ensure the printer is turned off;
- 2) Connect one end of the AC power input cable to power adapter, and then insert the other end of the power adapter into the power adapter interface on the back of printer;
- 3) Insert the other end of AC power input cable into the 220V power socket.



Caution

- If leaving the printer idle for a long time, please disconnect the power of printer.

2.4 Communication cable connection

- 1) Ensure the printer is turned off;
- 2) Insert the communication cable into the suitable interface, and fix it with screw or latch spring of the plug;
- 3) Connect the other end of the communication cable to the host.



Caution

- Don't connect or disconnect the serial/parallel communication cable when the power has not been turned off.

2.5 Start the printer

2.5.1 Power-on and self-test

- 1) Ensure the power adapter and the communication cable are connected correctly, and turn on the printer;
- 2) The printer starts the self-test. The buzzer beeps once for a short time after the self-test is finished, and then the LCD displays manufacturer LOGO and status information or product model;
- 3) If power-on action is set, the printer will perform power-on action.

Note: Power-on action refers to the actions performed automatically after the printer is turned on, including feeding one label, starting calibration automatically (only valid under discontinuous paper mode). The power-on action can be set by commands or configuration tools.



Caution

- If the printer can not be started or can not work normally after it is started, please contact SNBC or local dealer in time.

2.5.2 Printing self-test page

- 1) Install the media, and turn on the printer. The printer will feed paper and print self-test page (see [Appendix 2.1](#)) through button operations (for the detailed operation methods, please refer to [3.3.1 Button menu settings](#));
- 2) The self-test page lists the current configuration information of the printer.

2.6 Driver setup

The installation program of the driver is included in the CD packed with the printer, which can also be downloaded from the website www.newbeiyang.com.

- The 32-bit operating systems supported by the driver are as follows:
Windows 2000/Windows XP/Windows server 2003/Windows Vista/Windows server 2008/Windows 7/Windows 8.
 - The 64-bit operating systems supported by the driver are as follows:
Windows XP/Windows server 2003/Windows Vista/Windows server 2008/Windows 7/Windows 8.
- 1) Run "Setup.exe" in the driver package, and read the related software license agreement carefully. If you accept the items in the license agreement, please click "I accept the items in the software license agreement", and then click "Next" button;



- 2) Select printer type and model to be installed. If you want to set the printer as default printer, please check “Set As Default Printer” and click “Next”;

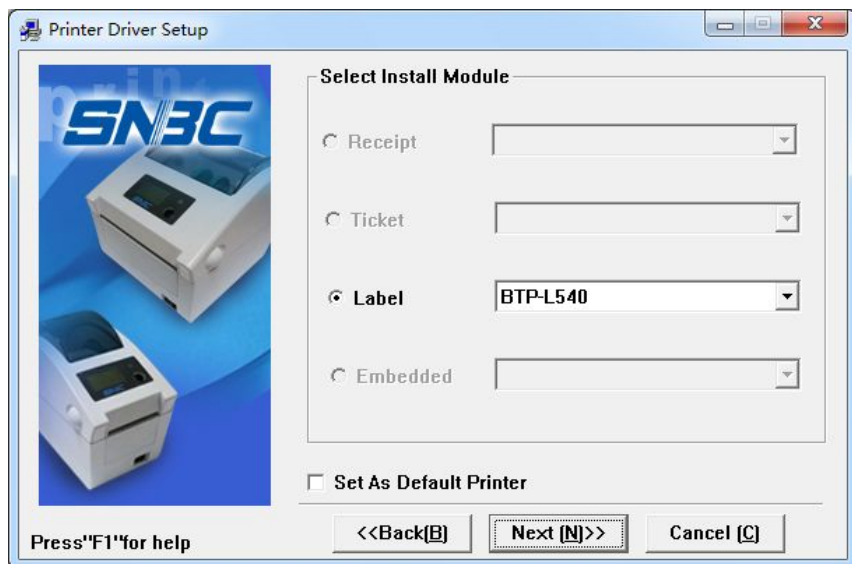

- 3) Select setup type, and click "Next";
- 4) The driver will select the current OS type automatically, and click "Next";
- 5) Set printer port. "LPT1" is set as the default print port, but users can select it according to actual needs. If it is a serial port driver, please select "BYCOMx" (x equals to 1, 2, 3, 4, 5, 6, 7 or 8); if it is Ethernet port, please select "NET"; if it is USB port, please select "USB_BTP-L540_x" (if USB port printer is connected correctly to the computer under power-on status, the driver setup program will set USB port as default port automatically). Then click "Install" to end the installation.

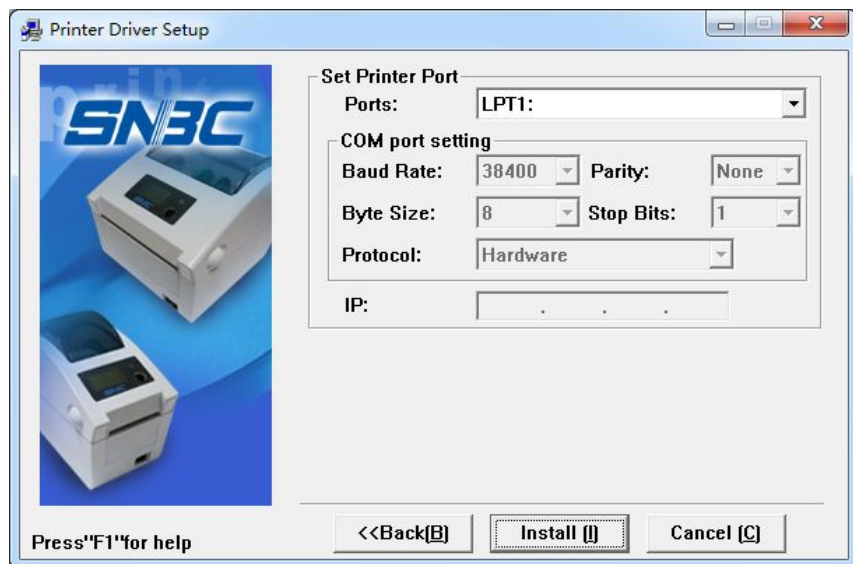

3 Printer operations

3.1 LED, buzzer, feed button and LCD

3.1.1 LED functions

LED name	Status	Explanation
Work LED (green)	Always on	Printer is idle or working.
	Flash twice	Prompt that the menu or parameter selection becomes effective. See 3.2.2 Daily operations for details.
Pause LED (orange)	Always on	Printer is in pause status.
Error LED (red)	Flash	An error occurs. See 5.1 Troubleshooting for details.

3.1.2 Button functions

Button	Function	Explanation
Short press	Feed paper	In standby status, press the button for a short time to feed paper.
	Pause	During the printing, press the button for a short time to enter pause status.
	Continue	After the printer enters pause status, press the button for a short time to resume the printing.
	Menu switching	After entering the menu, press the button for a short time to switch the menu.
	Parameter selection	After entering the submenu, press the button for a short time to select the parameter.
Long press	Enter the menu	When the printer is idle, press the button for a long time to enter the menu.

	Menu selection	After entering the menu, press the button for a long time to select the current menu.
	Parameter confirmation	When setting the parameter, press the button for a long time to validate the current parameter.

Note: Short press means the duration from pressing down the button to the time when the button uplifts is less than 0.5s.

Long press means the duration of pressing down the button is more than 1s.

3.1.3 Buzzer functions

- 1) The buzzer beeps for a short time when the printer is turned on or reset;
- 2) The buzzer beeps many times when an exception occurs. For the details, please refer to [5.1 Troubleshooting](#).

3.1.4 LCD functions

LCD is used to display the printer status and menu and configure the printer parameters by cooperating with the button.

3.2 Printer status and operation

3.2.1 Printer status

The printer has five status: idle status, working status, pause status, configuration status, and abnormal status.

Printer status	LED	LCD
Idle status	Green LED is always on.	Display LOGO and printer model information.
Working status	Green LED is always on.	Display LOGO and PRINTING....

Pause status	Orange LED is always on.	Display LOGO and pausing.
Configuration status	Green LED is always on.	Display configuration menu.
Abnormal status	Refer to 5.1 Troubleshooting .	

Note: The work LED flashes twice when pressing the button for a long time under any of the status listed above.

3.2.2 Daily operations

➤ Operations under idle status

It refers to the ready status when the printer is normal and waiting for an operation or a task. The printer enters idle status by default after turned on normally or returns to idle status after finishing performing a task. Under idle status, if pressing the button for a short time, the printer will feed paper; if pressing the button a long time and releasing the button after the green LED flashes twice, the printer will enter the menu.

➤ Operations under working status

It refers to the status when the printer has a print task. The printer will enter pause status if releasing the button after pressing it down at this time.

➤ Operations under pause status

The printer is under the status of stopping the print task temporarily. The printer will enter pause status under the following situations:

- 1) Select "PAUSE" through the menu;

- 2) Press down the button during the printing;
- 3) After an exception is removed.

When the printer is in pause status, press the button for a short time to resume the print task or press the button for a long time to enter the menu to realize the selection of more functions, such as canceling the print task, configuring the printer parameters, etc.

➤ Operations under configuration status

It refers to the status of setting the printer parameters. Select “SETUP” to enter the configuration menu through the menu. At this time, press the button for a short time to switch the menu or adjust the parameter or press the button for a long time to select the menu or validate the current parameter.

➤ Operations under abnormal status

It refers to the status when an exception occurs. The printer failure is prompted by LED, buzzer or LCD. For the details of failure prompt and removing, refer to [5.1 Troubleshooting](#).

3.3 Printer parameter settings

3.3.1 Button menu settings

When the printer is idle, enter the configuration status through long press of the button. The common parameters of printer can be set and saved under configuration status. Parameters can be configured by the cooperation of LCD and button.

The following describes the setting and saving of printer parameters by taking the serial port configuration for example:

- 1) Keep pressing the button until the green LED flashes under idle status. Then the LCD will display the menu as shown in figure 3.3.1-1.

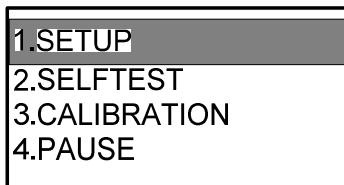

Figure 3.3.1-1 menu

Note: After entering the menu, the printer will exit the menu automatically if the menu is not operated in two minutes.

- 2) Press the button for a short time to switch to “SETUP” option. Then press the button for a long time and release it after the green LED flashes to select the option and enter configuration menu. Press the button for a short time to switch the menu to “SERIAL COM” option as shown in figure 3.3.1-2 and then press the button for a long time to enter the submenu.



Figure 3.3.1-2 configuration menu

- 3) Press the button for a short time to switch the submenu to “BAUDRATE” option as shown in figure 3.3.1-3.

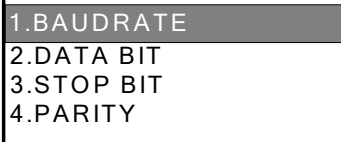

Figure 3.3.1-3 serial configuration menu

Press the button for a long time to enter baud rate configuration option as shown in figure 3.3.1-4. At this time, what is displayed on the LCD is the parameter being used now. If you do not want to change the parameter, press the button for a long time to exit the option; if you want to change the parameter, press the button for a short time to modify it.

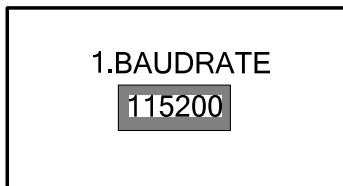

Figure 3.3.1-4 submenu of serial baud rate

- 4) Repeat step 1-3 to change other parameters of the serial port.
- 5) Save the modified parameters. Switch the menu to “SAVE ALL” option and press the button for a long time to save the modified parameters. The printer will restart automatically after the saving to validate the parameter changes. (Remarks: if “SAVE ALL” option is not executed, the printer will not save the setting and will execute the previous configuration parameters when powered on next time).
- 6) If you want to discard your changes, choose “EXIT” directly to

exit.

Configuring other parameters is similar to the process described above, which can be operated according to the menu prompts.

3.3.2 Detailed parameter setting range

Adjustment object	Setting range	Remarks
Paper type	CONTINUOUS MARK WEB	CONTINUOUS: continuous paper MARK: marked paper WEB: label paper, please see Appendix 1.2 technical specifications of paper for details.
Paper out mode	REWIND TEAR OFF PEEL OFF CUTTER	The peel off module and cutter are optional.
Print darkness	00—30	Set the print darkness as low as possible on condition that the print effect is acceptable so as to ensure the lifetime of print head.
Print speed (unit: IPS)	3-6	
Vertical position adjustment (unit: dots)	-120+120	For adjustment effect, please refer to 3.5 Print position adjustment .
Horizontal position adjustment (unit: dots)	-9999+9999	

dots)			
Tear-off position adjustment (unit: dots)		-120+120	
Time		00-23	Supported display format: MM/DD/YY 24HR MM/DD/YY 12HR DD/MM/YY 24HR DD/MM/YY 12HR
		00-59	
Date		00-99	
		01-12	
		01-31	
Paper calibration		None	The printer feeds paper and at the same time rectifies the sensor parameters in order to adapt to the paper.
Serial port configuration	Baud rate	110, 300, 600, 1200, 2400, 4800, 9600, 19200, 38400, 57600, 115200	
	Data bit (unit: bit)	7 bit, 8 bit	
	Stop bit (unit: bit)	1 bit, 2 bit	
	Parity	NONE, ODD, EVEN	
	Handshake signal	Hardware handshake, software handshake	

3.4 Sensor position adjustment

- A. When using label paper, the sensor position can be adjusted according to the following steps:
- 1) Push the part with arrow on the sensor cover board in the

direction of the arrow, and turn the sensor cover board upward to take it off (see figure 3.4-1);

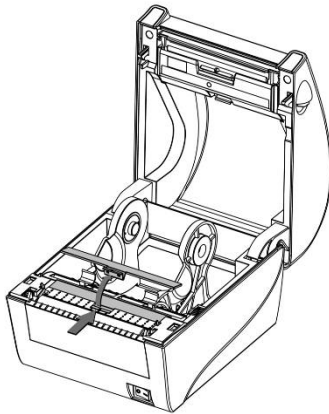

Figure 3.4-1

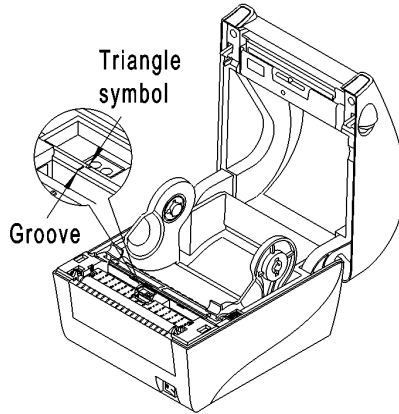

Figure 3.4-2

- 2) Pull or push the sensor base to align the triangle symbol on the sensor base with the groove on the upper path (see figure 3.4-2);
 - 3) Press down the part with arrow to install the sensor cover board.
- B. When using the label paper or changing the width of label paper, follow the steps below to adjust the sensor position:
- 1) Measure the required sensor position in advance based on the mark position of media;
 - 2) Push the part with arrow on the sensor cover board in the direction of the arrow, and turn the sensor cover board upward to take it off (see figure 3.4-1);
 - 3) Pull or push the sensor to the required position (as shown in the figure);

- 4) Press down the part with arrow to install the sensor cover board.

3.5 Print position adjustment

1) Adjust vertical print position

When the situation like figure A or B occurs, adjust the vertical print position to figure C. (For the detailed adjustment method, please refer to [3.3.1 Button menu settings](#)).

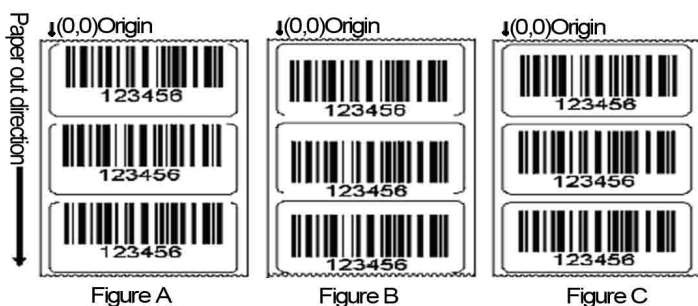

Figure 3.5-1

Caution:

- Figure A indicates that the print position is upper than the correct position. Adjust it in the negative direction (The data symbol in the option “Vertical position adjustment” is “+”);
 - Figure B indicates that the print position is lower than the correct position. Adjust it in the positive direction. (The data symbol in the option “Vertical position adjustment” is “-”).
- #### 2) Adjust horizontal print position

When the situation like figure D or E occurs, adjust the horizontal print position to figure F (For the detailed adjustment method, please refer to [3.3.2 Detailed parameter setting range](#)).

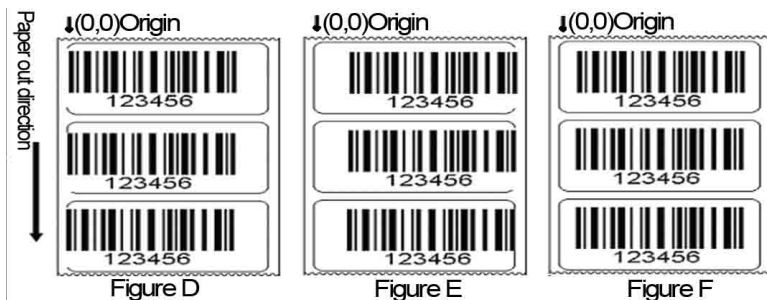

Figure 3.5-2

⚠ Caution:

- Figure D indicates that the print position is on the left of the correct position. Adjust it in the positive direction (The data symbol in the option “Horizontal position adjustment” is “+”);
- Figure E indicates that the print position is on the right of the correct position. Adjust it in the negative direction. (The data symbol in the option “Horizontal position adjustment” is “-”).

3) Adjust tear-off position

When the situation like figure G or H occurs, adjust the tear-off position to figure J. (For the detailed adjustment method, please refer to 3.3.2 Detailed parameter setting range).

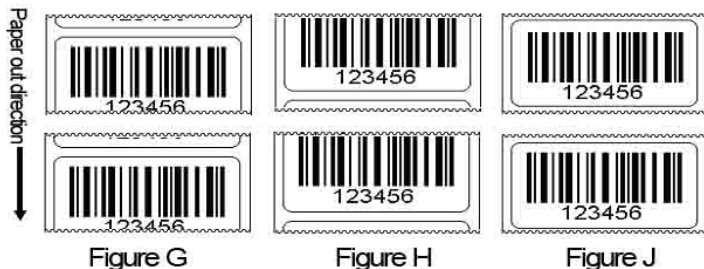

Figure 3.5-3

**Caution:**

- Figure G indicates that the tear-off position is upper than the correct position. Adjust it in negative direction; (The data symbol in the option “Tear-off position adjustment” is “-”);
- Figure H indicates that the tear-off position is lower than the correct position. Adjust it in positive direction. (The data symbol in the option “Tear-off position adjustment” is “+”).

4 Routine maintenance

Clean the print head, platen roller and sensor every month according to the following steps. If the printer works in a tough environment, the maintenance times can be properly increased.

4.1 Cleaning print head

When any of the following cases occurs, the print head should be cleaned:

- Printout is not clear;
- Feed or retract paper with big noise;
- Something else sticks onto the print head.

Follow the steps below to clean the print head:

- 1) Turn off the printer and open the top cover;
- 2) Lift up the top cover and find the print head. Wait for print head to cool down completely if it has just finished the printing;
- 3) Wipe off the dust and stains on the surface of the print head with alcohol cotton ball (it should be wrung out);
- 4) Wait for 5 to 10 minutes until the alcohol evaporates completely, press down print head module, and close the top cover.

4.2 Cleaning the sensor

When any of the following cases occurs, the mark sensor should be cleaned:

- During printing, the printer sometimes misinforms paper end;
- The printer does not alarm when paper end;
- The printer cannot identify marks effectively.

Follow the steps below to clean the mark sensor:

A. Transmissive sensor

- 1) Turn off the printer and open the top cover;
- 2) Wipe off the dust and stains on the surface of the transmissive sensor with alcohol cotton ball (it should be wrung out);
- 3) Wait for 5 to 10 minutes until the alcohol evaporates completely, and close top cover.

B. Reflective sensor

- 1) Turn off the printer and open the top cover;
- 2) Find the reflective sensor and take off the top cover board of it;
- 3) Wipe off dust and stains on the surface of sensor with alcohol cotton ball (it should be wrung out);
- 4) Wait for 5 to 10 minutes until the alcohol evaporates completely, close the top cover board of the sensor, and close the top cover.

4.3 Cleaning platen roller

When any of the following cases occurs, the platen roller should be cleaned:

- Printout is not clear;
- Feed and retract paper with big noise;
- Something else sticks onto the platen roller.

Follow the steps below to clean the platen roller:

- 1) Turn off the printer and open the top cover;
- 2) Uplift the top cover and find the platen roller. Wait for the platen

- roller to cool down completely if it has just finished printing;
- 3) Wipe off the dust and stains on the surface of the platen roller with alcohol cotton ball (it should be wrung out) while turning the platen roller;
 - 4) Wait for 5 to 10 minutes until the alcohol evaporates completely, and close the top cover.

**Caution**

- Before starting routine maintenance of printer, make sure the printer is turned off;
- Do not touch the surface of print head with hands or metal. Do not use forceps in case it scratches the surface of the print head, platen roller and sensor;
- Do not use organic solvent like gasoline, acetone etc. to clean the print head or platen roller;
- Do paper calibration again after cleaning the paper end sensor;
- Please wait for alcohol to evaporate completely before starting printing.

5 Troubleshooting

When the printer has a malfunction, please handle it with reference to this charter. If it still can not be cleared, please contact SNBC or your local dealer.

5.1 Troubleshooting

The error LED flashes and the buzzer beeps when an error or exceptional status occurs. At this time, the printer stops the printing. Please handle it with reference to the following method:

Error indication mode:

Error message	Buzzer	Error LED	LCD
Print head up	2 beeps	Flash 2 times circularly	Display LOGO and "COVER OPEN"
Paper end	3 beeps	Flash 3 times circularly	Display LOGO and "PAPER END"
Abnormal temperature of print head	No beep	Flash 5 times circularly	Display LOGO and "PRINT HEAD TOO COLD OR HOT"
Mark location failure	No beep	Flash 6 times circularly	Display LOGO and "MARK ERROR"
Mark calibration error	No beep	Flash 7 times circularly	Display LOGO and "CALIBRATION FAILED"

Troubleshooting methods:

Error LED status	Reason analysis	Solutions
Print head up	Print head is lifted up.	Please press down the print head.
	The micro switch has a failure.	Contact the maintainer.
Paper end	Paper roll is used up or no paper roll is installed.	Install a paper roll.
	Paper jam	Clear the paper jam.
	Paper roll surface is dirty or damaged.	Please skip the dirty or damaged part.
	Paper roll breaks away from the mark sensor.	Install a paper roll again.
	The surface of mark sensor is dirty.	Clean mark sensor surface.
	The position of reflective sensor is not correct.	Adjust the sensor position according to the description in 3.4.
	Paper roll type does not match with mark sensor type.	Set the paper type in printer driver to make it consistent with actual paper type.
Print head temperature abnormal	Operating environment temperature is too high, causing overheating print head.	Please improve ventilation condition. The printer can return to normal with the fall of temperature.
	Print darkness is too high.	Lower the print darkness properly.
	Paper is jammed in the path, causing heat accumulation and	Clear paper jam. Check if the print head test pattern is normal or not after the temperature of print head

	overheating print head.	drops. If normal, the printer can continue to work; otherwise please replace the print head.
Mark location failure or mark calibration failure	Paper type does not match with sensor type.	Set the paper type in printer driver to make it consistent with actual paper type.
	Something wrong with marked paper (for example: no mark or unclear mark)	Use the required media.
	Mark height is less than the required height.	

Table 5.1-1

5.2 Print quality problems

Malfunction	Reason	Solution
Printout is unclear or has stains.	Print head or platen roller is dirty.	Clean the print head or platen roller.
	Paper does not meet the requirement.	Use recommended paper.
	Print darkness is too low.	Increase print darkness.
	Paper is not installed correctly.	Install paper roll correctly.

Table 5.2-1

6 Appendix

Appendix 1 technical specification

Appendix 1.1 main technical specifications

	Item	BTP-L540 parameter
Printing	Resolution	203DPI
	Print method	Thermal
	Print width (Max.)	104mm
	Print speed (Max.)	152mm/s
	CPU	32bit RISC microprocessor
	Memory	FLASH: 4MB SDRAM: 64MB Extended FLASH: it can be extended to 8MB.
	Print head temperature detection	Thermal resistor
	Print head position detection	Micro switch
	Paper mark detection	Photoelectric sensor
	Paper existence detection	Photoelectric sensor

	Communication interface	USB interface or USB interface + optional interface; Optional interface: serial interface, CENTRONICS parallel interface, Ethernet interface and WLAN interface.
Media	Paper type	Continuous paper, label paper, marked paper, etc.
	Paper roll OD (Max.)	127mm (5 inches)
	Paper roll width (Max.)	120mm
	Paper roll ID	12.5mm (0.5 inch)/25mm (1 inch)
	Paper out mode	Tear off, peel-off, etc.
Character Barcode Graphics	Character enlargement/rotation	Support four types of rotation printing (0°, 90°, 180°, 270°) Bitmap fonts can be enlarged up to 10 times. Vector fonts can be zoomed without scale.
	Character set	7 bitmap fonts and 1 vector font are built-in.
		User-defined bitmap and vector fonts can be downloaded into the printer.
Graphics	Plain bitmaps in binary system, HEX, PCX, BMP and IMG files can be downloaded to FLASH or RAM.	

	Barcode	1D Barcode: Code39, Code93, Codabar, Code128(Subsets A, B, and C), EAN-13, EAN-8, UPC-A, UPC-E, UPC/EAN Extensions, Planet Code, Standard 2 of 5, Industrial 2 of 5, Interleaved 2 of 5, LOGMARS, GS1 DataBar (RSS) 2D Barcode: PDF 417, MicroPDF417, QR Code, DataMatrix, MaxiCode, GS1 Composite
Operation interface	Button, LED, LCD	1 button, 1 LED, 1 LCD
Power adapter	Input	AC 110~240V, 50/60Hz
	Output	DC 24V, 2.5A
Environmental requirements	Operating environment	+5°C~45°C, 20%~90%(40°C)
	Storage environment	-40°C~60°C, 20%~93%(40°C)
Physical features	Overall size	210mm*167mm*172mm (L*H*W)
	Weight	1.6Kg

Table appendix 1.1-1

Appendix 1.2 technical specifications of paper

1) Specifications of continuous paper (unit: mm)

Type	Illustration	Index
Continuous paper without adhesive		Print paper width: $18 \leq a \leq 120$
Continuous paper with adhesive		Base paper width: $18 \leq a \leq 120$ Print paper width: $18 \leq b \leq 118$ Paper margin width: $c \leq 1$

Table appendix 1.2-1

2) Discontinuous paper specifications (unit: mm)

Type	Illustration	Index
Discontinuous label paper with adhesive		Base paper width: $18 \leq a \leq 120$ Paper margin width: $b \leq 1$ Label width: $18 \leq c \leq 118$ Label height: $d \geq 10$ Gap width: $e \geq 2$

<p>Discontinuous punched paper without adhesive</p>		<p>Punched paper width: $18 \leq a \leq 120$ Punched paper height: $b \geq 10$ Detection hole position: $c \leq a/2$ Detection hole width: $d \geq 5$ Detection hole height: $e \geq 2$</p>
<p>Discontinuous marked paper without adhesive</p>		<p>Marked paper width: $18 \leq a \leq 120$ Marked paper height: $b \geq 10$ Mark position: $c \leq a/2$ Mark width: $d \geq 10$ Mark height: $e \geq 4$</p>

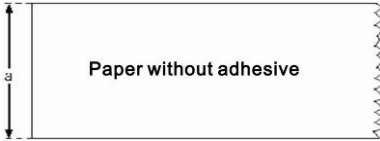
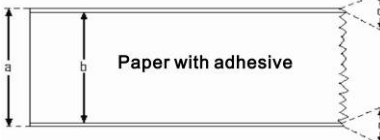
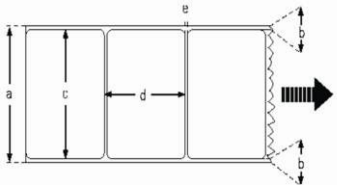
Table appendix 1.2-2

Appendix 2 self-test page

Self-test page includes printer configuration information, printer internal fonts and print head test information. The printer configuration information and printer internal fonts reflect the current internal configuration of the printer, and the print head test information reflects the status of the print head.

Appendix 2.1 printer configuration information

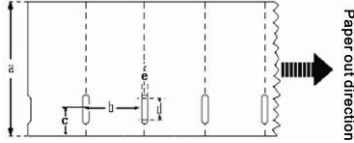
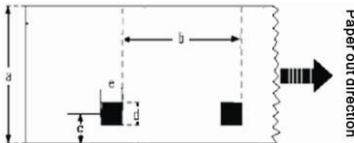
Printer configuration information (BPLZ II) (this information is related to the configuration of the printer.)

PRINTER CONFIGURATION

BTP-L540.....	MODEL
FV1.000.....	MAIN FIRMWARE
0.....	DARKNESS
+0.....	TEAR OFF
TEAR OFF.....	PRINT MODE
CONTINUOUS.....	MEDIA TYPE
MEDIA.....	SENSOR TYPE
MANUAL.....	SENSOR SELECT
DIRECT-THERMAL.....	PRINT METHOD
56.....	PRINT WIDTH
640.	LABEL LENGTH
11IN 300MM.....	MAXIMUM LENGTH
CONNECTED.....	USB COMM
NONE.....	PARALLEL COMM
115200.....	BAUD
8 BITS.....	DATA BITS
NONE.....	PARITY
HARD.....	HOST HANDSHAKE
NONE.....	PROTOCOL
<~> 7EH.....	CONTROL CHAR
<^> 5EH.....	COMMAND CHAR
<, > 2CH.....	DELIM. CHAR
NO MOTION.....	MEDIA POWER UP
NO MOTION.....	HEAD CLOSE
DEFAULT.....	BACKFEED

+0.....	LABEL TOP
+0.....	LEFT POSITION
152mm/s.....	PRINT SPEED
152mm/s.....	FEED SPEED
152mm/s.....	BACKFEED SPEED
203DPI.....	RESOLUTION
16360K.....	R: RAM
1472K.....	E: ONBOARD FLASH
NONE.....	FORMAT CONVERT
0123456789.....	SERIAL NUMBER

Appendix 3 print and paper out position

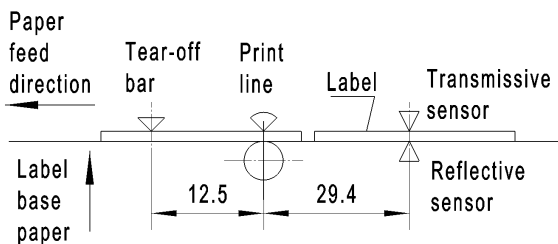

Figure appendix 3-1



Caution

- To take marked paper for example, the figure above explains the print and paper out position;
- Discontinuous paper locates by the front edge of the mark;
- Refer to [3.5](#) to adjust the print and paper out position.

Appendix 4 communication interface

Appendix 4.1 serial interface

1) Interface signal

Pin	Signal name	Signal direction	Function
1	None		
2	RXD	Input	Data input
3	TXD	Output	Data output
4	DTR	Output	Data terminal ready
5	SG	—	Signal ground
6	DSR	Input	Data device ready
7	RTS	Output	Request transmission
8	CTS	Input	Allow transmission
9	FG	—	Frame ground

Table appendix 4.1-1 printer signal and status

2) Wiring diagram

```

PC           Printer
TXD-----RXD
RXD-----TXD
CTS-----RTS
RTS-----CTS
SG -----SG
    
```



Caution

- The following connection method can be used, which only needs 3 wires. This method applies to small data amount or XON/XOFF flow control:

```

PC           Printer
TXD-----RXD
    
```

RXD-----TXD

SG -----SG

Appendix 4.2 parallel interface

Parallel interface works under IEEE1284 compatible mode.

Pin	Definition	Description	Pin	Definition	Description
1	Input	/STROBE	13	Output	SELECT
2	Input	Data0	14	Input	/AutoFd
3	Input	Data1	15	Not defined	NC
4	Input	Data2	16	-	Logic Ground
5	Input	Data3	17	-	Chassis Ground
6	Input	Data4	18	-	Vcc
7	Input	Data5	19 ~ 30	-	Signal Ground
8	Input	Data6	31	Input	/Init
9	Input	Data7	32	Output	/Fault
10	Output	/ACK	33	-	Ground
11	Output	BUSY	34 ~ 35	Not defined	/NC
12	Output	PEerror	36	Input	/SelectIn

Table appendix 4.2-1 parallel signal list

Caution

- In the process of data transmission, the host computer should not ignore the Busy signal; otherwise the print data may be lost;
- Parallel interface signal adopts TTL level. Ensure the rise and fall time of host computer is not longer than 0.5μs when it is used.

Appendix 4.3 USB interface

USB interface meets USB1.1 protocol standard and is optional.

USB interface transmits signal and power via a four-wire cable, as shown in the following figure:

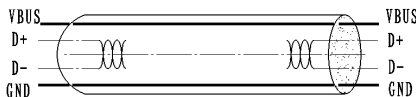

Figure appendix 4.3-1 USB cable

Wire D+ and D- in figure appendix 4.3.1 are used for signal transmission, and the VBUS is +5V.

Appendix 4.4 Ethernet interface

Ethernet interface meets the standard communication protocol of 10/100M BASE-T in IEEE802.3 and is optional.

PIN	Signal name	Signal direction	Function
P1	TX+	Output +	Difference data signal output+
P2	TX-	Output -	Difference data signal output-
P3	RX+	Input +	Difference data signal input+
P4	Reserve	—	—
P5	Reserve	—	—
P6	RX-	Input -	Difference data signal input-
P7	Reserve	—	—
P8	Reserve	—	—
G+	VCC	power	SPEED_LED power
G-	SPEED_LED	output	SPEED LED signal
Y-	LINK_LED	output	LINK LED signal
Y+	VCC	power	LINK_LED power

Table appendix 4.4-1 Ethernet signal list

Appendix 5 operation guide for paper loading under peel-off mode (optional)

When using label paper with adhesive, the user can refer to “2.4 Installing paper roll” for installation, and the paper out mode can be set to peel-off mode. When peel-off mode is selected, follow the steps below to load paper:

- 1) Remove several labels on the front of label paper, ensure the front of base paper is flush, and pull the peel-off turn board outward (see figure appendix 5-1);
- 2) Pass the base paper through the peel-off module according to the path shown in the figure (see figure appendix 5-2);

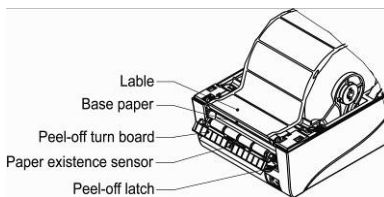

Figure appendix 5-1

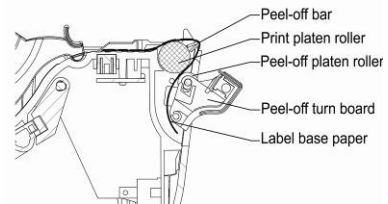

Figure appendix 5-2

- 3) Push the peel-off turn board back into place and keep the base paper in tension state to end paper loading.
- 4) When the printer is working, it peels labels off the base paper and sends each label out one by one. After the user takes the label away from the printer, the printer will continue to execute the next command.